

**Ultra Thin Speaker**

**Model: OST45R-5B1.0W4N**



**ELECTRICAL SPECIFICATIONS**

	Condition	Parameter	Unit
Sound Pressure Level	at 0.1W, 0.1M [at 0.8, 1.0, 1.2, 1.5 KHz]	88 ± 3	dB
Impedance	at 1V, 800Hz	4 ± 15%	Ω
Rated Input Power		1	W
Max Input Power		1.2	W
Resonant Frequency (Fo)	at 1V	450 ± 20%	Hz
Frequency Range		Fo ~ 6000	Hz
Buzzer & Rattles	not be audible at sine wave between Fo ~ 6KHz	2	V
Operating Temperature		-20 ~ 60	°C
Magnet		Nd-Fe-B	
Frame Material		Metal	
Cone Material		Mylar (PET)	
Weight		13	g
Dustproof And Waterproof Level	IEC 529 edition 2.0 (1989)	IP65	

Note: IP protection level for speaker front side when built into sealed housing.

**MECHANICAL DRAWING**

Dimensions in mm

Tolerance ±0.5mm Except Specified

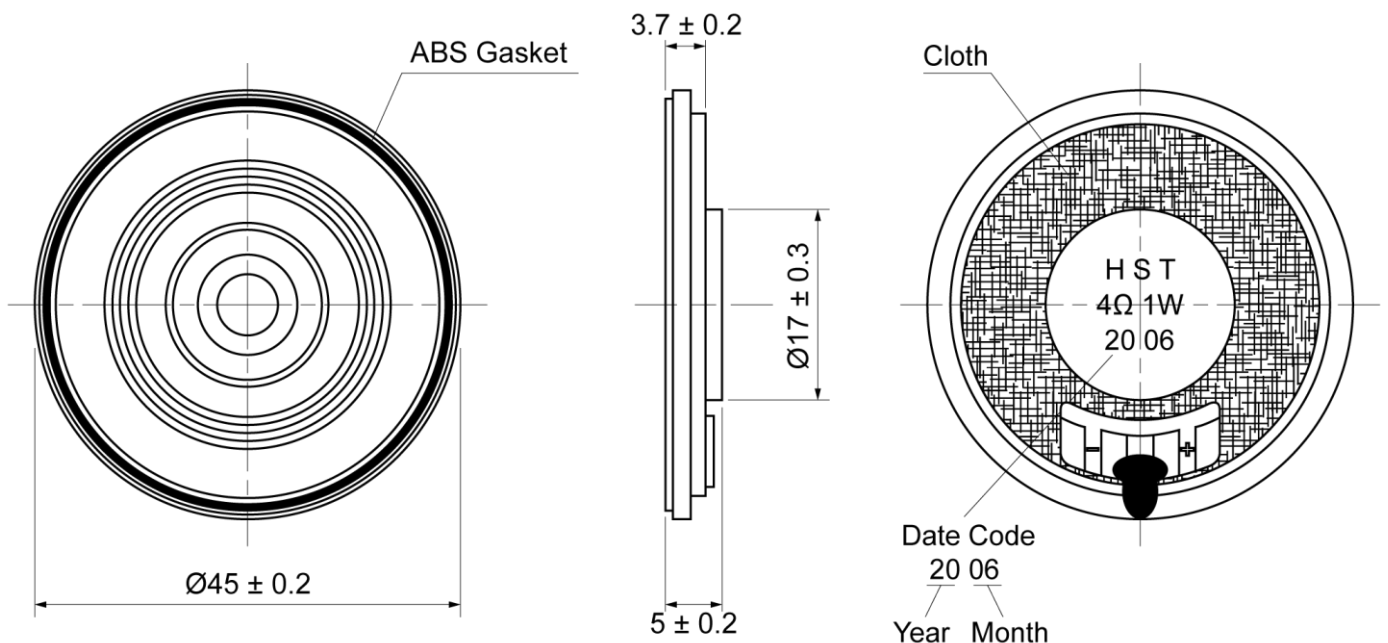

**Ultra Thin Speaker**

**Model: OST45R-5B1.0W4N**

**FREQUENCY RESPONSE CURVE**

